



***Time Electronics***  
*Calibration, Test and Measurement*

# User Manual

## 1017 DC Multifunction Calibrator

Version 1.4  
02/24

### **Time Electronics Ltd**

Unit 5, TON Business Park, 2-8 Morley Road,  
Tonbridge, Kent, TN9 1RA, United Kingdom.

T: +44 (0) 1732 355993 | F: +44 (0) 1732 350198  
mail@timeelectronics.co.uk | www.timeelectronics.com

© 2024 Time Electronics Ltd.

All rights reserved.

Nothing from this manual may be multiplied, or made public in any form or manner, either electronically or hard copy, without prior written consent from Time Electronics Ltd.

This also applies to any schematics, drawings and diagrams contained herein.

This manual provides operating and safety instructions for the Time Electronics product.

To ensure correct operation and safety, please follow the instructions in this manual.

Time Electronics reserves the right to change the contents, specifications and other information contained in this manual without notice.

# Contents

<b>1</b>	<b>Introduction.....</b>	<b>4</b>
1.1	Description.....	4
1.2	Specifications .....	5
1.3	Circuit Description .....	6
1.4	Power Supply Description.....	6
<b>2</b>	<b>Front Panel Controls .....</b>	<b>7</b>
<b>3</b>	<b>Operation.....</b>	<b>8</b>
3.1	Preparing for Use .....	8
3.2	Using the 1017 .....	9
3.3	Thermal EMF's .....	10
3.4	Using the Deviation Control.....	10
<b>4</b>	<b>Calibration.....</b>	<b>11</b>
4.1	Calibrating the 1017 .....	11
4.2	Zero Adjustment .....	11
4.3	Calibrating the Full Scales .....	12
4.4	Calibrating the Deviation Control .....	12
<b>5</b>	<b>Warranty and Servicing.....</b>	<b>13</b>

# 1 Introduction



## 1.1 Description

A high-performance portable multifunction calibrator with voltage, current, and resistance ranges. The 1017 combines precision with simple operation, making it suitable for use in the laboratory or field. Constructed in a compact and durable plastic case with a tilt stand/carry handle it takes up minimal bench space and is easily transportable.

Five DC voltage ranges from 10 mV to 100 V full scale are available, each with a 6-digit (1 ppm) resolution. The DC current range is 100 mA full scale with a 100 nA (1 ppm) resolution. Resistance from 0.01  $\Omega$  to 10 k $\Omega$  is available in 0.01  $\Omega$  steps.

**Stability and Temperature Coefficient:** Long-term stability is achieved by the use of high-quality components and modern resistor technology. The 1017 features a precision reference diode that provides the input to the unit's active circuitry. The special low-thermal emf terminals reduce errors when working with microvolt signals.

**Digital Deviation Control:** Allows the output to be increased and decreased in % terms from 0 to  $\pm 0.999$  %. This provides a direct read-out of error and simplifies the recording results for calibration certificates. It enables the user to immediately see if the unit under test is within specification.

**Portable Operation:** The 1017 can be powered from mains supply or by the internal rechargeable battery pack. Battery operation enables good performance where earth loop and noise pick-up occurs. When the calibrator is plugged into the mains supply the internal batteries will automatically start to recharge. If unplugged from the mains during operation the internal batteries will continue to power the instrument. Full charge allows 12 hours typical use. An LED indicator on the front panel displays the battery condition.

## 1.2 Specifications

Specifications apply at 23 °C ± 5 °C.

<b>Voltage ranges / accuracy</b> .....	10mV range: 0 to 9.99999mV in 10 nV steps / ± 0.02 % of setting ± 0.005% of range. 100mV range: 0 to 99.9999 mV in 100 nV steps / ± 0.01% of setting ± 0.004% of range. 1V range: 0 to 999.999 mV in 1µV steps / ± 0.005 % of setting ± 0.002 % of range. 10V range: 0 to 9.99999 V in 10 µV steps / ± 0.005 % of setting ± 0.002 % of range. 100V range: 0 to 99.9999 V in 100 µV steps / ± 0.01 % of setting ± 0.004 % of range.  <i>The above accuracies are independent of thermal emfs which can be 2 µV or more depending on the type of leads and connections used.</i>
<b>Output resistance</b> .....	10 mV and 100 mV ranges: 10 Ω. 1 V and 10 V: < 150 mΩ. 100 V: < 1 Ω.
<b>Drive current max</b> .....	10 and 100 mV ranges: as 10 Ω output resistance. V and 10 V: 150 mA; 100 V: 10 mA.
<b>Current range / accuracy</b> .....	100mA range: 0 to 99.9999 mA in 0.1 µA steps / ± 0.02 % of setting ± 0.004 % of range.
<b>Drive voltage max</b> .....	10 V.
<b>Resistance range/accuracy</b> ....	10 kΩ range: 0 to 9.99999 kΩ in 0.01 Ω steps / ± 0.05 % of full scale.
<b>Power rating</b> .....	0.25 W per resistor.
<b>Residual resistance</b> .....	Less than 200 mΩ.
<b>Deviation control (V&amp;I)</b> .....	0 % to 0.999 % in 0.001 % steps. Deviation accuracy: V and I output, 0.5 %.
<b>Temperature coefficient</b> .....	Voltage and current ranges: < 10 ppm/°C. Resistance ranges: < 30 ppm/°C.
<b>Long term stability</b> .....	5 ppm/day, < 15 ppm/90-day (at a constant temperature), < 25 ppm/year.
<b>Short term stability – noise</b> ....	10 mV range: < 0.2 µV/sec, < 0.3 µV/10sec, < 0.4 µV/min. 100 mV range: < 0.2 µV/sec < 0.4 µV/10 sec, < 0.6 µV/min. 1 V range: < 0.2 µV/sec, < 0.5 µV/10sec, < 1.5 µV/min. 10 V range: < 1.0 µV/sec, < 2.0 µV/10sec, < 8.0 µV/min. 100 V range: <4 0 µV/sec, < 100 µV/10sec, < 500 µV/min. 100 mA range: < 0.2 µA/sec, < 0.4 µA/10sec, < 1.0 µA/min.
<b>Warm-up and settling time</b> .....	Warm-up: < 10 mins to full accuracy. Settling: < 0.5 secs, 100 V range: 5 secs.
<b>Output connections</b> .....	The output is via low thermal emf terminals (0.2 µV/°C). A mains earth terminal is provided for screening purposes. Output polarity can be selected by a switch on the front panel.
<b>Power supply</b> .....	The 1017 can be powered continuously from a 230 V 50/60 Hz (110 V to order) main supply, or from the internal rechargeable NiCad battery pack.
<b>Battery level indicator</b> .....	A front panel LED provides an indication of the battery condition.

## General Specifications

<b>Operating temperature</b> .....	0 to 50 °C (32 to 120 °F). Full specification: 23 °C ± 5 °C.
<b>Operating humidity</b> .....	10 to 90 % non-condensing 25 °C (77 °F).
<b>Dimensions</b> .....	W 250 x H 119 x D 314 mm.
<b>Weight</b> .....	2.4 kg.
<b>Optional extras</b> .....	Calibration certificates - traceable (factory) or accredited (ISO 17025).
<b>Country of origin</b> .....	UK.

## Ordering Information

<b>1017</b> .....	Multifunction Voltage/Current/Resistance Calibrator
<b>C152</b> .....	Traceable calibration certificate (Factory)
<b>C109</b> .....	Accredited calibration certificate (ISO 17025)

## 1.3 Circuit Description

The calibrator employs a temperature compensated zener diode as the basic reference source. This provides the input to an FET chopper amplifier system which operates in a feed-back stabilised mode, and has a gain value determined by a set of precision wire-wound resistors which are selected by a 6 decade thumbwheel switch. The output voltage is variable from 0 V to 99.9999 V in 5 ranges.

An output resistance of typically 150 m $\Omega$  is maintained on all ranges excluding the 100 V range where the output resistance is 1  $\Omega$ . The maximum output current that can be drawn on the 10 V and 1 V ranges is automatically limited to approximately 150 mA, or 15 mA on the 100 mV range. It must be noted that the current on the 10 mV range is limited by a 1  $\Omega$  resistance. The output current on the 100 V range is 10 mA.

The 100 V output is generated by driving a step-up transformer with the 'chopped' D.C. output from the output of the module. Feedback around the complete amplifier regulates the output to the set output value.

When the 100 mA range is selected, the output current is sensed by a precision resistor. The voltage generated across this resistor is used to control the output drive voltage, so regulating the output current.

The resistance range operates by directly switching the thumbwheel switch to the output terminals.

The deviation control operates by injecting a current into the reference circuitry which either increases or decreases the reference voltage.

To ensure complete reliability of the thumbwheel switch, double pole gold plated contacts are used for each position – even if a contact fails, the 1017 will continue to work correctly.

## 1.4 Power Supply Description

The power supply employed in the 1017 is a Time Electronics design type PU2. This unit incorporates a rechargeable battery pack for portable use, the pack is automatically charged when mains power is connected. The PU2 is mounted internally on the rear panel of the 1017. The power supply is set for 220V – 240V AC mains unless otherwise specified.

When mains power is connected, the built-in charger of the PU2 provides the correct charge current (40 to 45 mA) for the battery and automatically reduces this to a trickle charge (3 to 4 mA) when the battery is fully charged. This management of the charge current means that it is almost impossible to over-charge the battery, therefore maximising the battery life. Approximately 30 to 40 hours use may be obtained between charges, depending on the output, and function setting.

## 2 Front Panel Controls

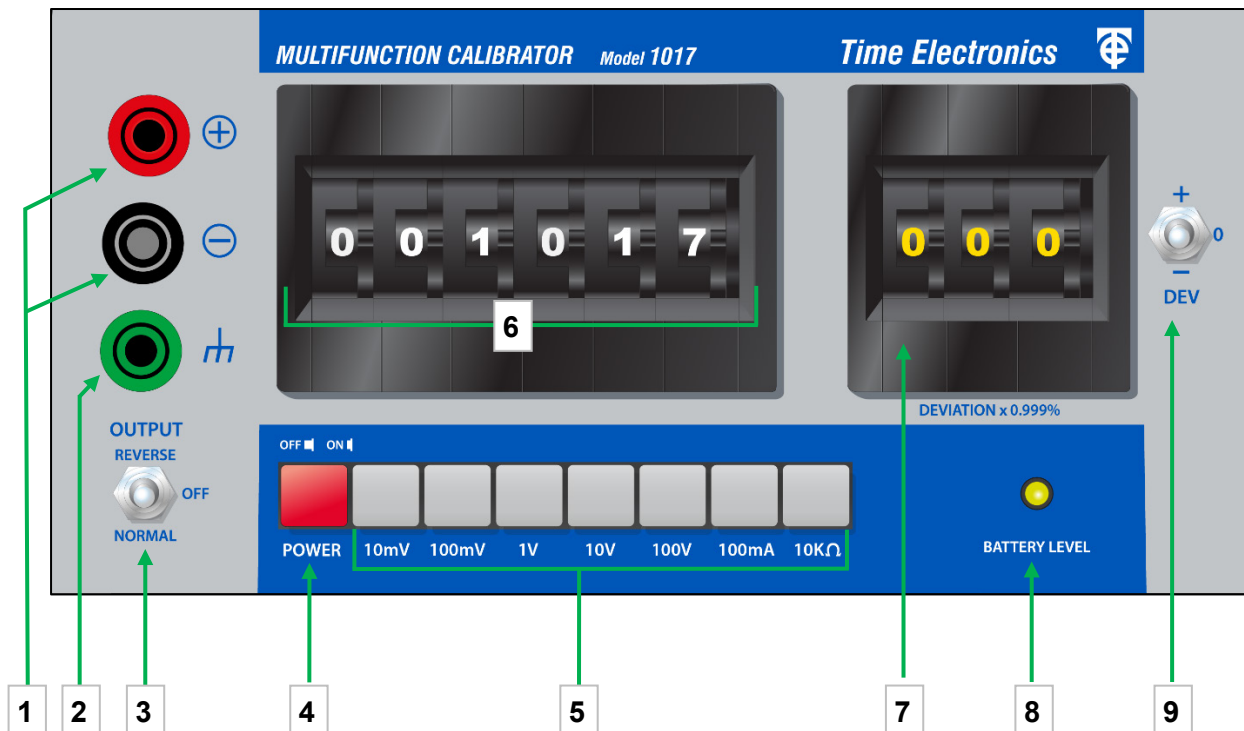

**1 – Output Terminals.**

**2 – Case Terminal.**

**3 – Reverse / Off / Normal Switch.** Selects the output polarity.

**4 – Power On / Off Switch.** Indication is shown by the Battery Level Indicator.

**5 – Functions and Range Selection Buttons.** Selects the function for use.

The labelled range is based on maximum output of the function.

**6 – Output Setting Switch.** Sets the value of output, on a 6-digit thumbwheel switch.

**7 – Deviation Digit Switch.** Selects the value of Deviation.

**8 – Battery Level Indicator.** Shows the state of charge of the batteries. When green the unit is powered on and battery level is good. When red, the batteries need recharging.

**9 – Positive / Off / Negative Deviation Control.** Applies a Positive or Negative Deviation to the output as a percentage.

## 3 Operation



### 3.1 Preparing for Use

If using the 1017 unplugged from a mains supply, you must first check the battery level. The battery level is continuously monitored on a front panel LED indicator which also serves as a supply on-off indication. When green the unit is powered on and battery level is good. When red, the batteries need recharging. Recharge them by plugging the 1017 into a mains supply. It will take approximately 12 to 14 hours to fully recharge the battery pack.

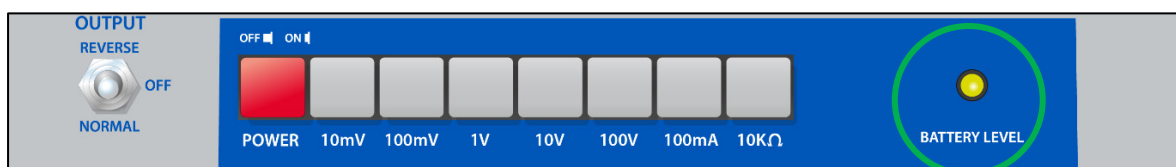

You can use the 1017 when it is plugged into the mains supply irrespective of the battery state. The batteries should also be checked during operation.



### 3.2 Using the 1017

1. Set the correct function and range from the selection buttons. Ensure that the output polarity switch is 'OFF' and that nothing is dialled up on the digit switch.

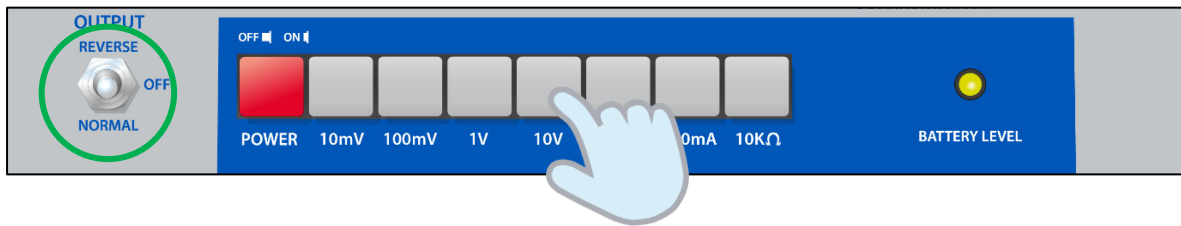

2. Set the required value on the output setting switch.

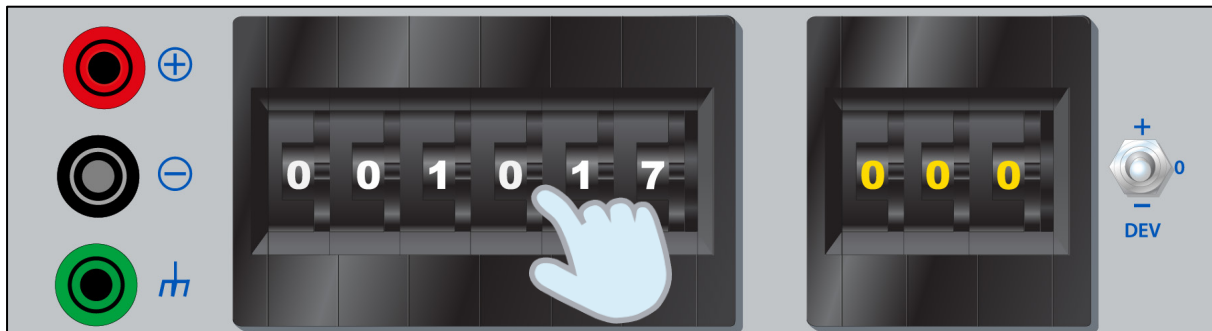

3. The output can be supplied to the unit under test by selecting the output polarity switch.



**Note:** When the output switch is set to the 'OFF' position, there is a short circuit on the output terminals.



**Caution:** must be exercised when using the 100 V range against possible electrical shock.

### 3.3 Thermal EMF's

When using the 1017 to provide a precision voltage of less than 1mV, care must be taken to avoid Thermal EMF's. These occur where temperature differences are present at the junctions of dissimilar metals, e.g. – A normal solder to copper junction has a thermal EMF of approximately  $3 \mu\text{V}/^\circ\text{C}$ . Errors in the 1017 under stable temperature conditions are typically less than  $\pm 0.2 \mu\text{V}/^\circ\text{C}$ .

### 3.4 Using the Deviation Control

**Note:** The digital deviation control has no effect if used on the resistance range.

To apply a percentage deviation to the output, select either positive or negative deviation with the control switch and dial the percentage deviation required on the digit switch.



Alternatively, if the output is set to the correct value and the reading on the U.U.T. reading differs from this, adjust the deviation control to give the required value. The error can then be read directly, as a percentage, from the deviation control.

## 4 Calibration

### 4.1 Calibrating the 1017

The 1017 can be calibrated with a high accuracy multimeter with DC voltage, current and resistance ranges with a specification of at least 4 times greater than that of the 1017's specifications. Calibration is best carried out on fully charged batteries without the mains supply connected to ensure that no mains supply interference takes any effect on the readings.

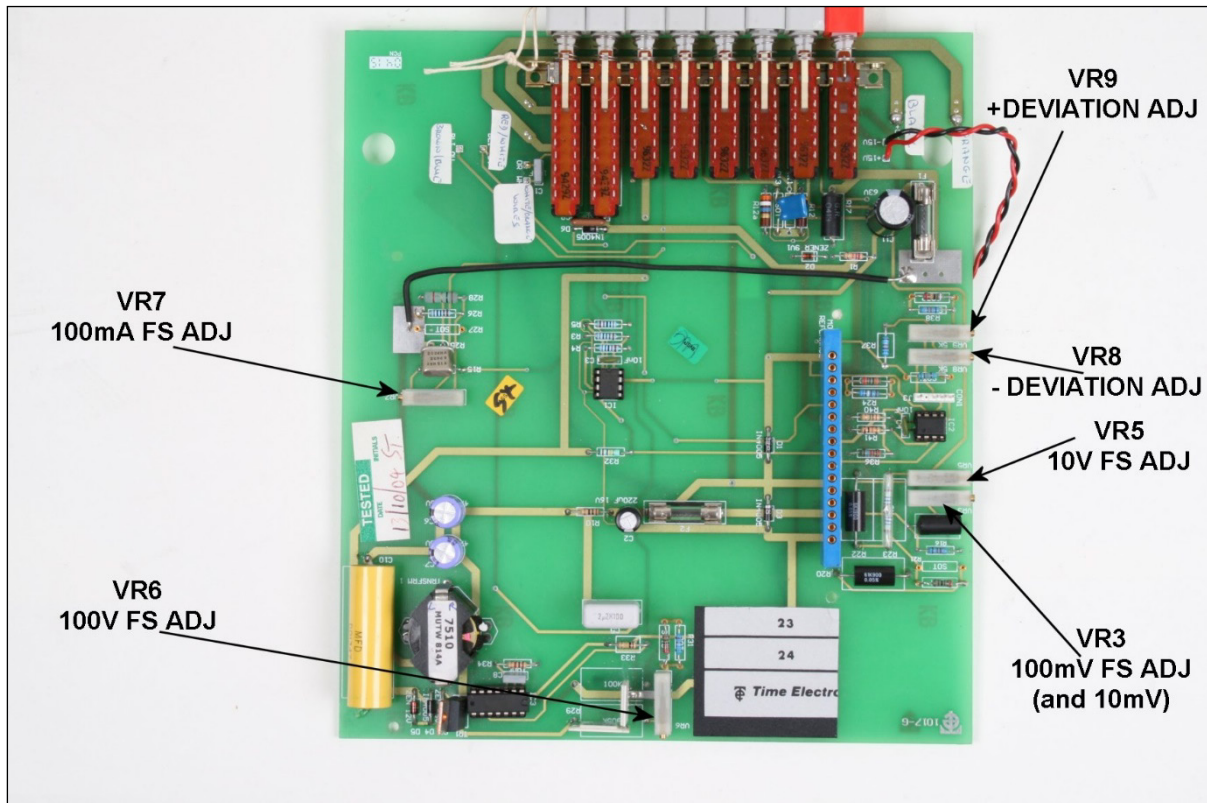

### 4.2 Zero Adjustment

Select 1 V range, set all digit switches to zero, adjust zero trimmer on module to within  $\pm 6 \mu\text{V}$  of absolute zero.

Range	Allowance	Adjust Pot
1 V	$6 \mu\text{V}$	1 V ZERO ON MODULE

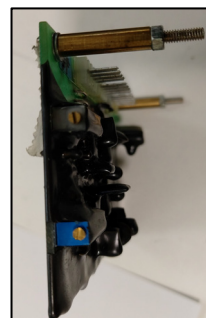
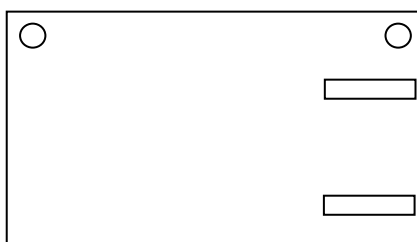

## 4.3 Calibrating the Full Scales

After checking the zero settings you may then calibrate the full scales.  
Set the digit switch to '999999'.

### **Select 1 V range:**

Adjust the 1 V Full Scale with the 'CAL' trimmer which is on the potted module.  
Adjust this to read 999.999 mV to within 20  $\mu$ V.

### **Select 10V range:**

Adjust the 10 V F.S. trimmer, VR5, to read 9.99999 V to within  $\pm$  200  $\mu$ V.

### **Select 100 mV range:**

Adjust the 100 mV & 10 mV F.S. trimmer VR3, to read 99.9999 mV to within  $\pm$  4.3  $\mu$ V

### **Select 10 mV range:**

Check 9.99999 mV F.S. is within 1.3  $\mu$ V (note the adjustment is done on the 100 mV range)

### **Select 100 V range:**

Adjust the 100 V F.S. trimmer, VR6, to read 99.9999 V to within  $\pm$  3.5 mV.

### **Select 100 mA range:**

Adjust the 100 mA F.S. trimmer, VR7, to read 99.9999 mA to within  $\pm$  6  $\mu$ A.

## 4.4 Calibrating the Deviation Control

Set the output to the 1 V on the 1 V range and set the deviation to +0.999 %. Adjust the output using the + Deviation trimmer, VR9, to read 1.01 V to within 5 mV.

Leaving the output at 1 V on the 1 V range, set the deviation to -0.999 %. Adjust the output using the - Deviation trimmer, VR8, to read 0.99 V to within 5 mV.

The calibration procedure is now complete.

## 5 Warranty and Servicing

### Warranty

Time Electronics products carry a one-year manufacturer's warranty as standard.

Time Electronics products are designed and manufactured to the highest standards and specifications to assure the quality and performance required by all sectors of industry. Time Electronics products are fully guaranteed against faulty materials and workmanship.

Should this product be found to be defective, please contact us using the below details. Inform us of the product type, serial number, and details of any fault and/or the service required. Please retain the supplier invoice as proof of purchase.

This warranty does not apply to defects resulting from action of the user such as misuse, operation outside of specification, improper maintenance or repair, or unauthorized modification. Time Electronics' total liability is limited to repair or replacement of the product. Note that if Time Electronics determine that the fault on a returned product has been caused by the user, we will contact the customer before proceeding with any repair.

### Product Registration

You can register your product at: [www.timeelectronics.com/contact/product-registration](http://www.timeelectronics.com/contact/product-registration)  
Registering your product will enable us to maintain a record of purchase for your warranty. You can also use the web form to provide feedback about our products and services.

### Calibration and Repair Services

Time Electronics offers repair and calibration services for all the products we make and sell. Routine maintenance by the manufacturer ensures optimal performance and condition of the product. Periodic traceable or accredited calibration is available.

### Contacting Time Electronics

#### **Online:**

Please visit [www.timeelectronics.com](http://www.timeelectronics.com) and select Technical Support from the Contact links. From this page you will be able to send information to the Time Electronics service team who will help and support you.

#### **By phone:**

+44 (0) 1732 355993

#### **By email:**

[mail@timeelectronics.co.uk](mailto:mail@timeelectronics.co.uk)

## Returning Instruments

Prior to returning your product please contact Time Electronics. We will issue a return merchandise authorization (RMA) number that is to accompany the goods returning. Further instructions will also be issued prior to shipment. When returning instruments, please ensure that they have been adequately packed, preferably in the original packing supplied.

**Time Electronics Ltd will not accept responsibility for units returned damaged.**

Please ensure that all units have details of the service required and all relevant paperwork.

Send the instrument, shipping charges paid to:

### **Time Electronics Ltd**

Unit 5, TON Business Park, 2-8 Morley Road,  
Tonbridge, Kent, TN9 1RA.  
United Kingdom.

Tel: +44(0)1732 355993

Fax: +44(0)1732 350198

Email: [mail@timeelectronics.co.uk](mailto:mail@timeelectronics.co.uk)

Web Site: [www.timeelectronics.com](http://www.timeelectronics.com)

---

## Disposal of your old equipment

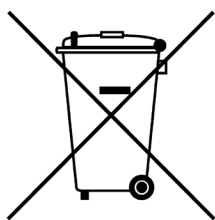

1. When this crossed-out wheeled bin symbol is attached to a product it means the product is covered by the European Directive 2002/96/EC.
2. All electrical and electronic products should be disposed of separately from the municipal waste stream via designated collection facilities appointed by the government or the local authorities.
3. The correct disposal of your old appliance will help prevent potential negative consequences for the environment and human health.
4. For more detailed information about disposal of your old appliance, please contact your city office, waste disposal service or return to Time Electronics.